

ŽU 110 – montážní návod (mounting instructions)

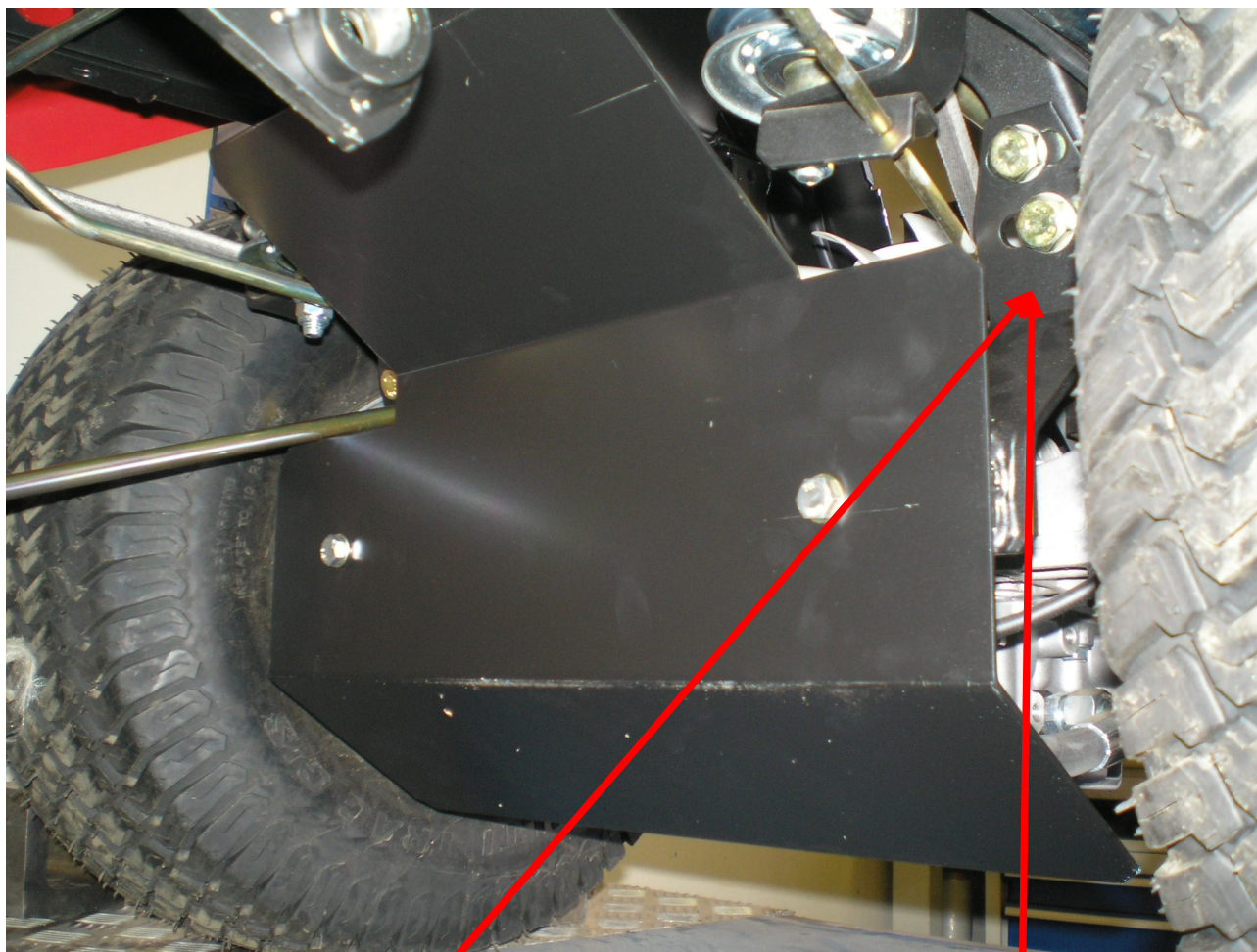

Sezona 2011



Sezona 2010

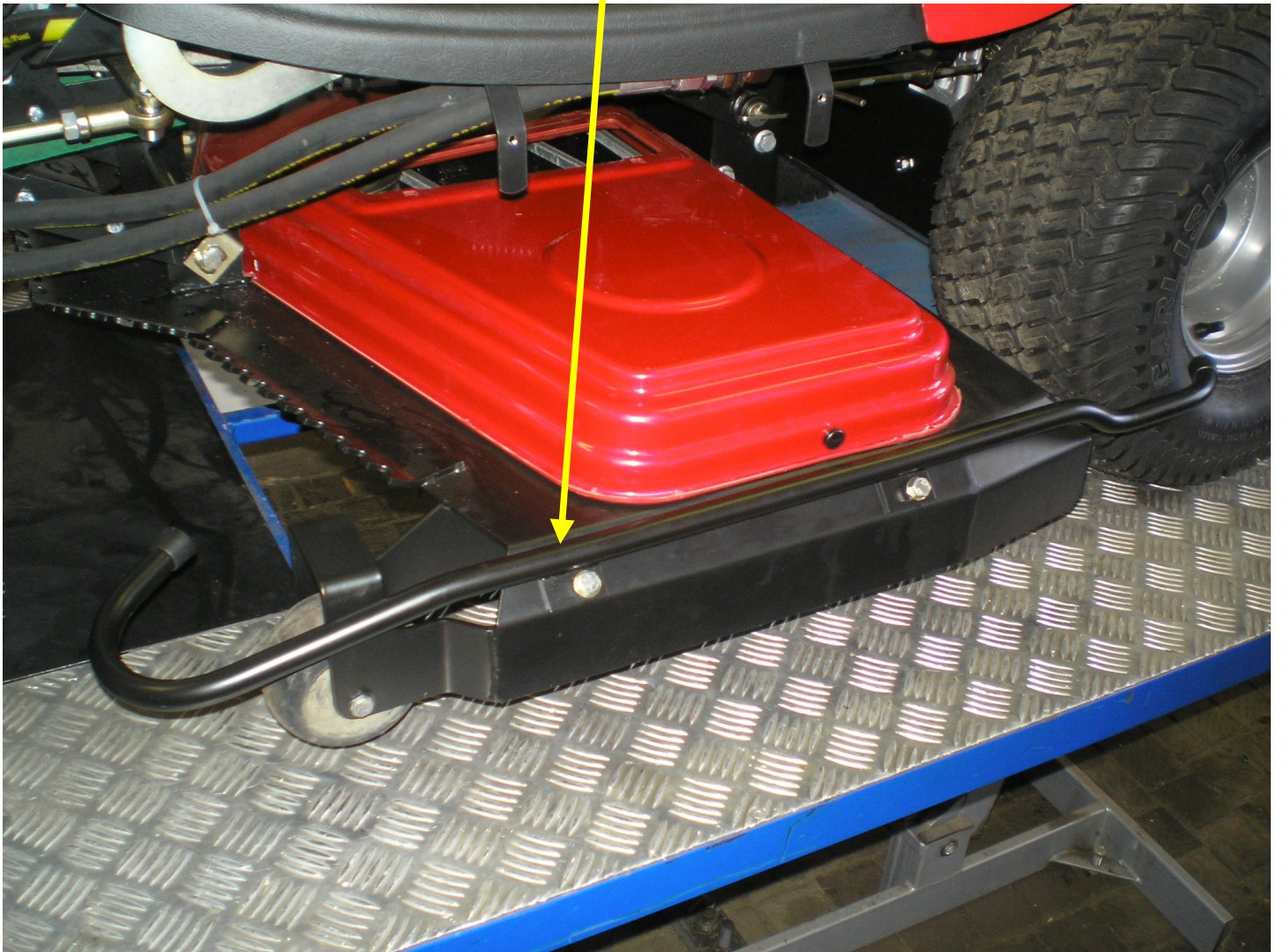

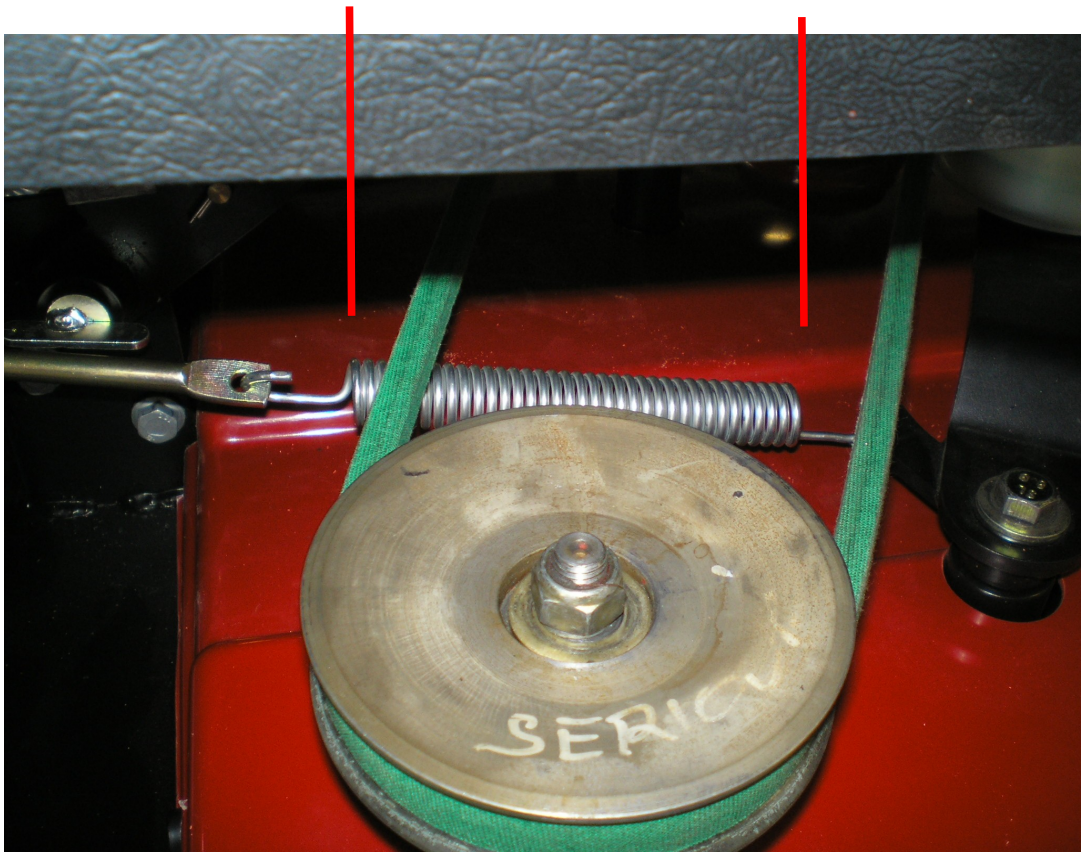
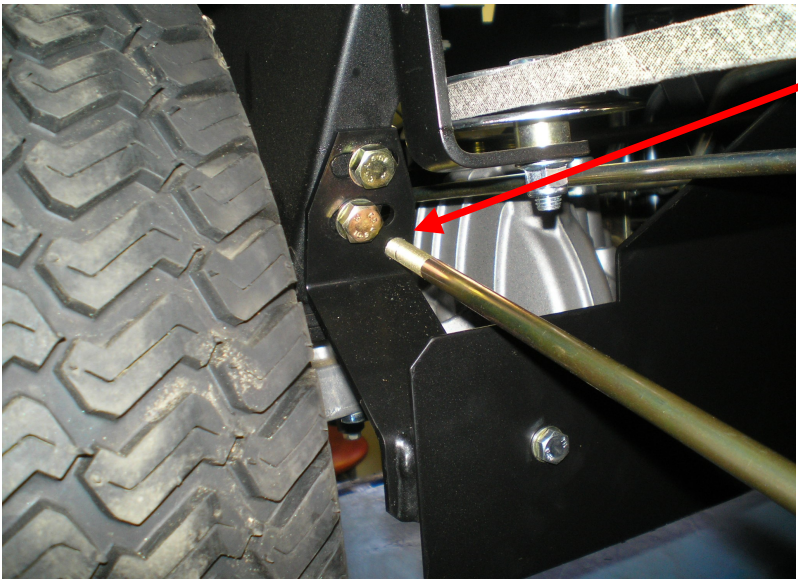

135 +/- 1 mm

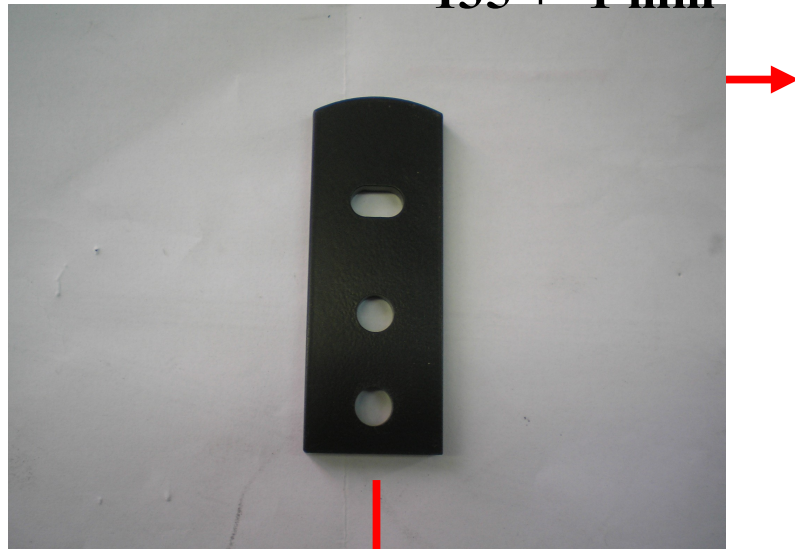

V 7. poloze zdvihu
In 7. position stroke

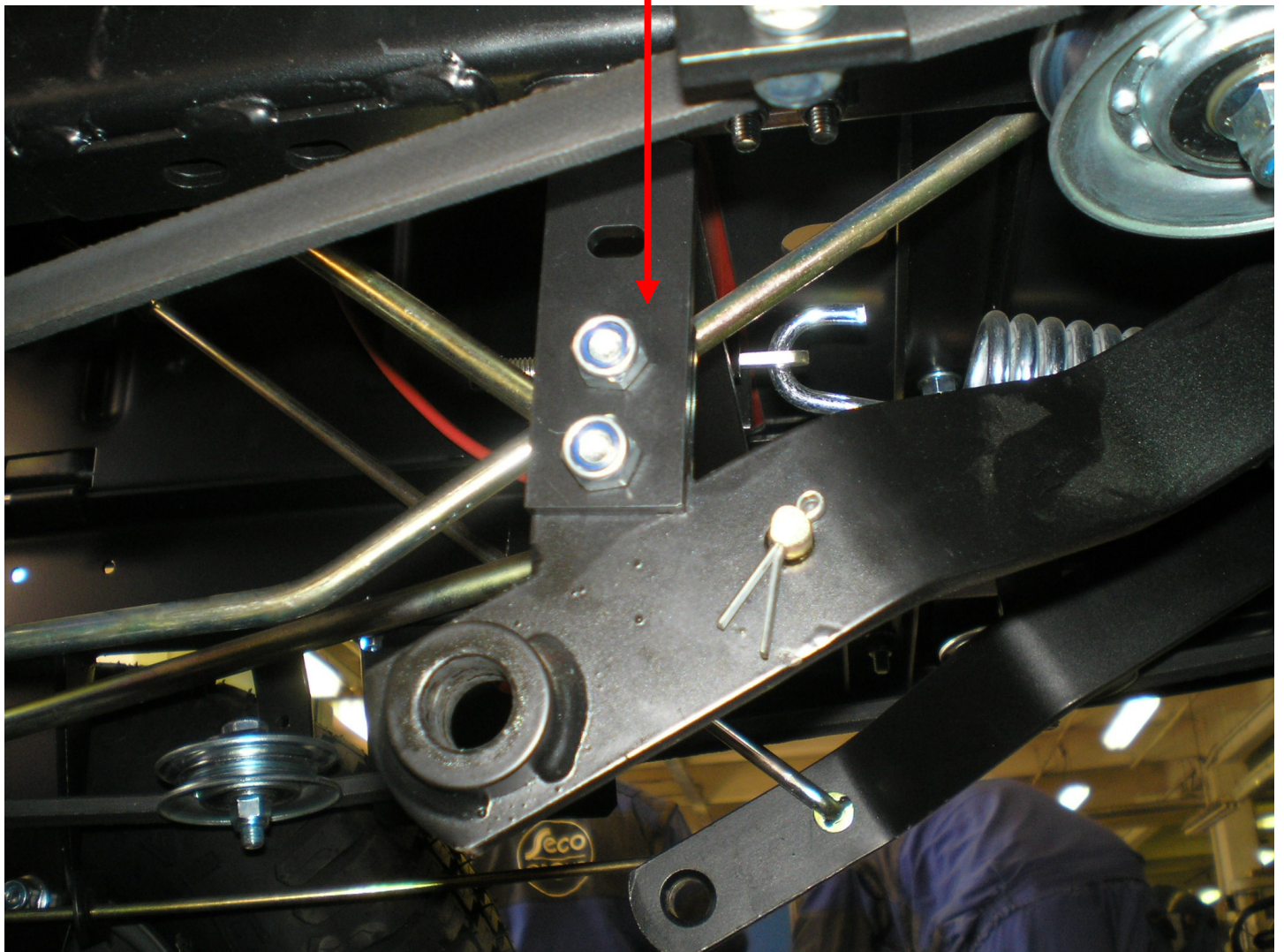

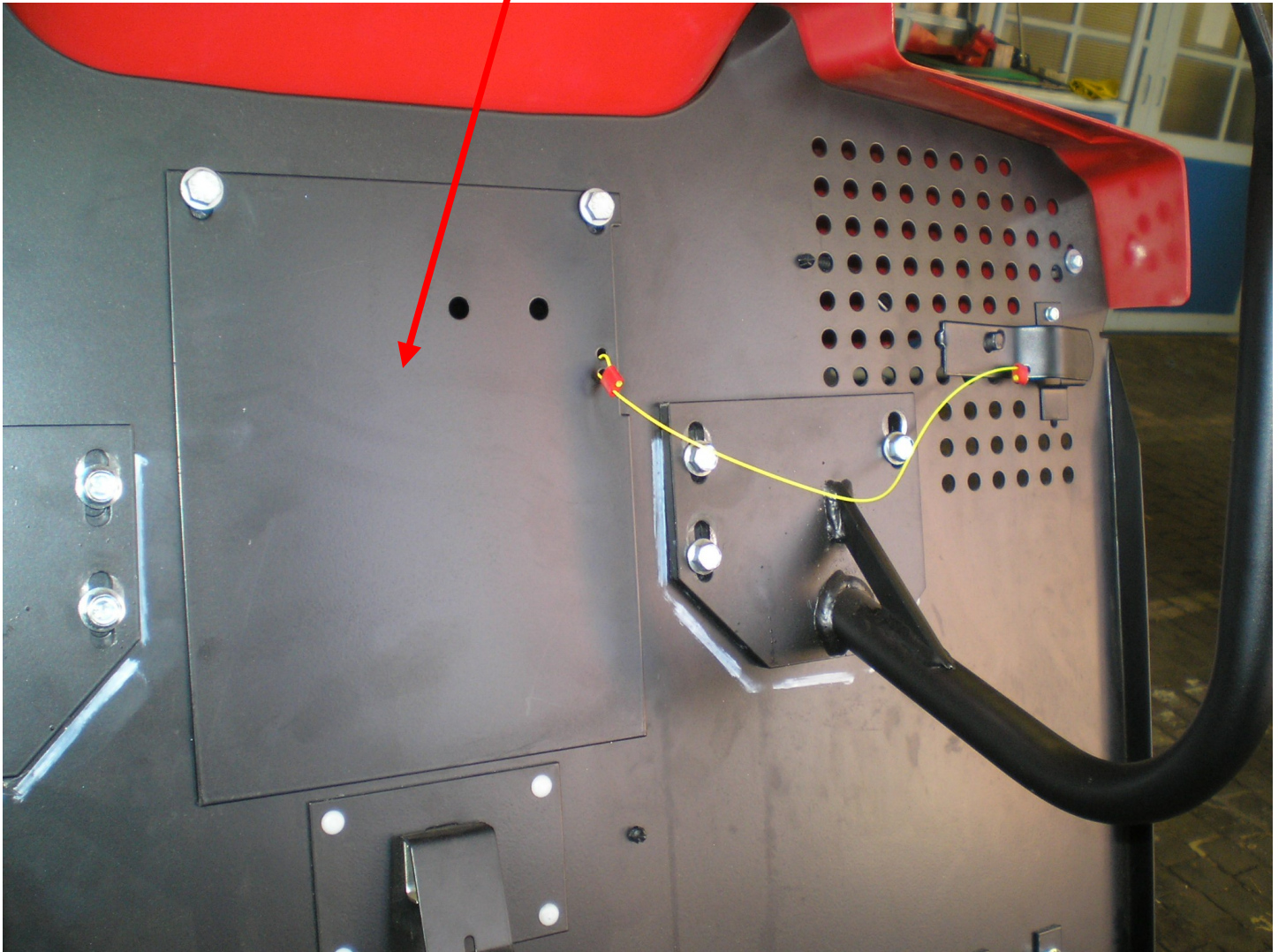
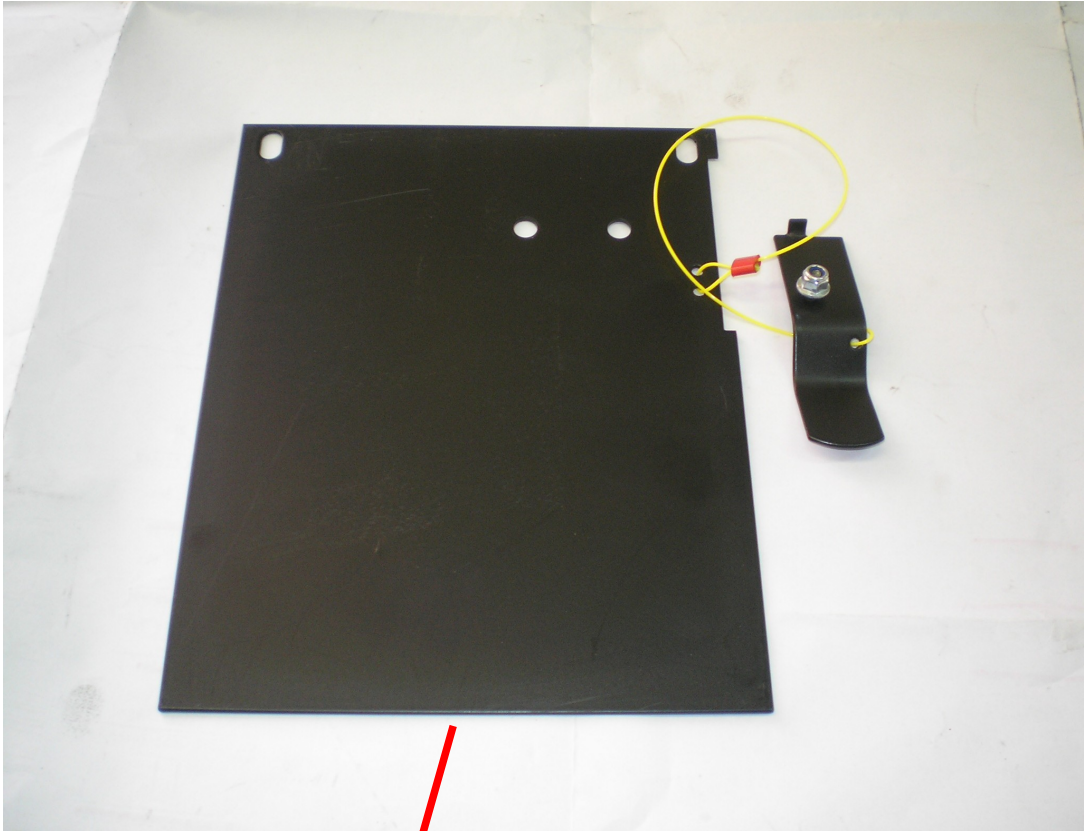

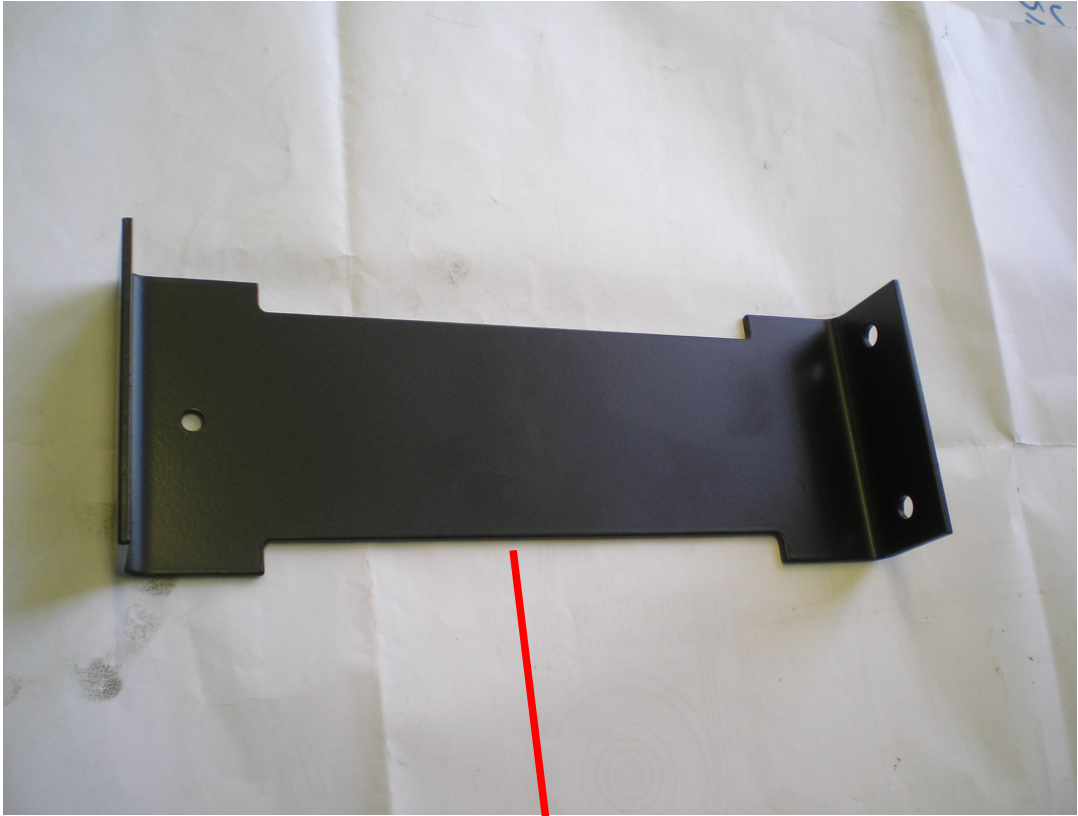

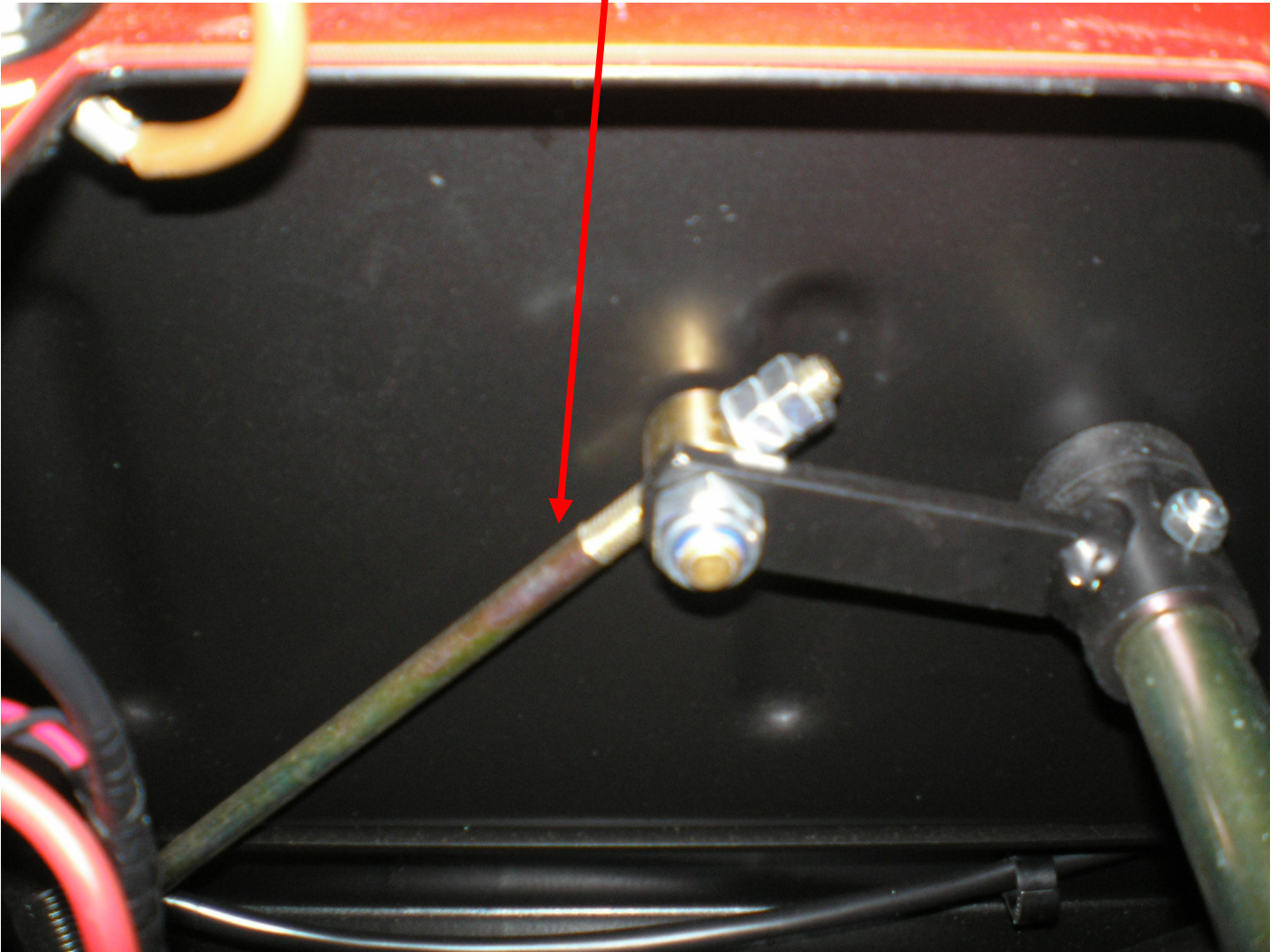
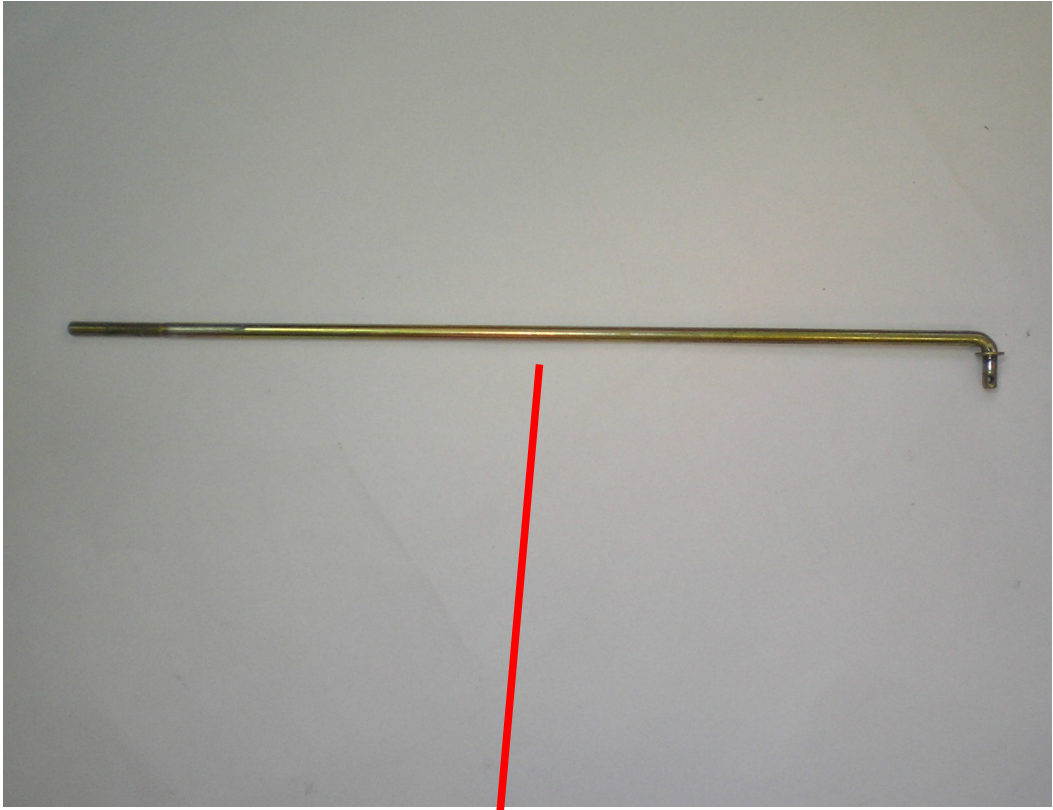

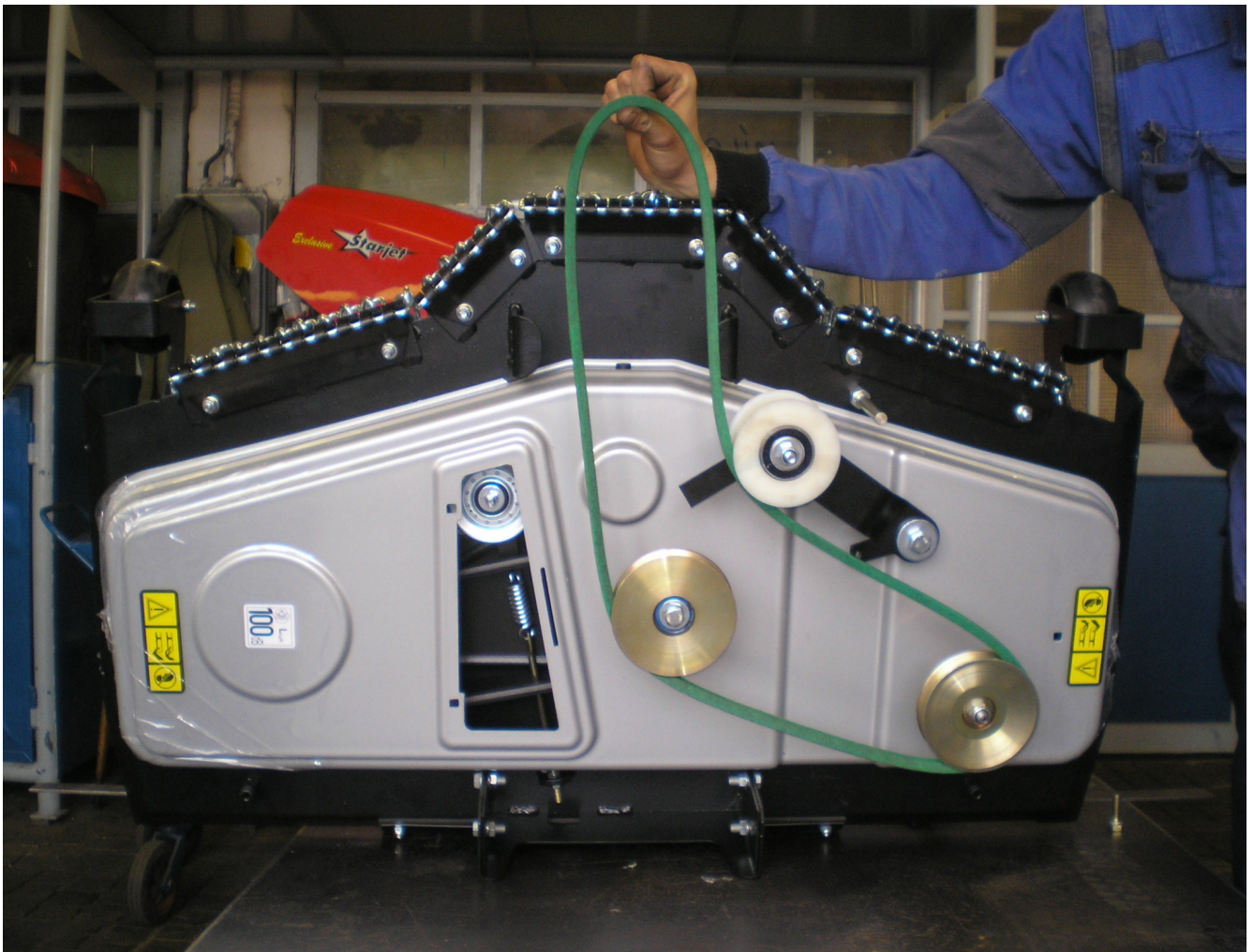
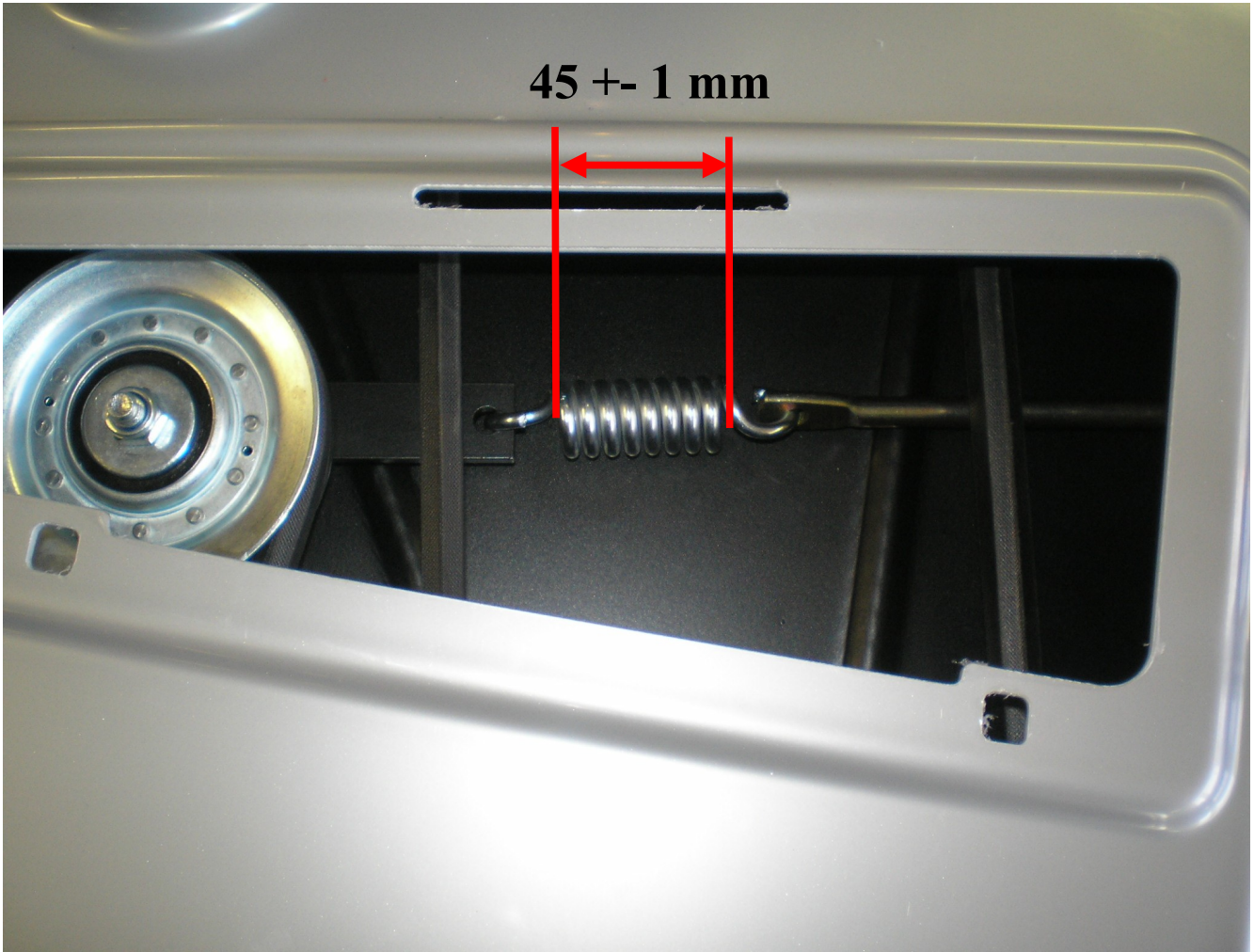

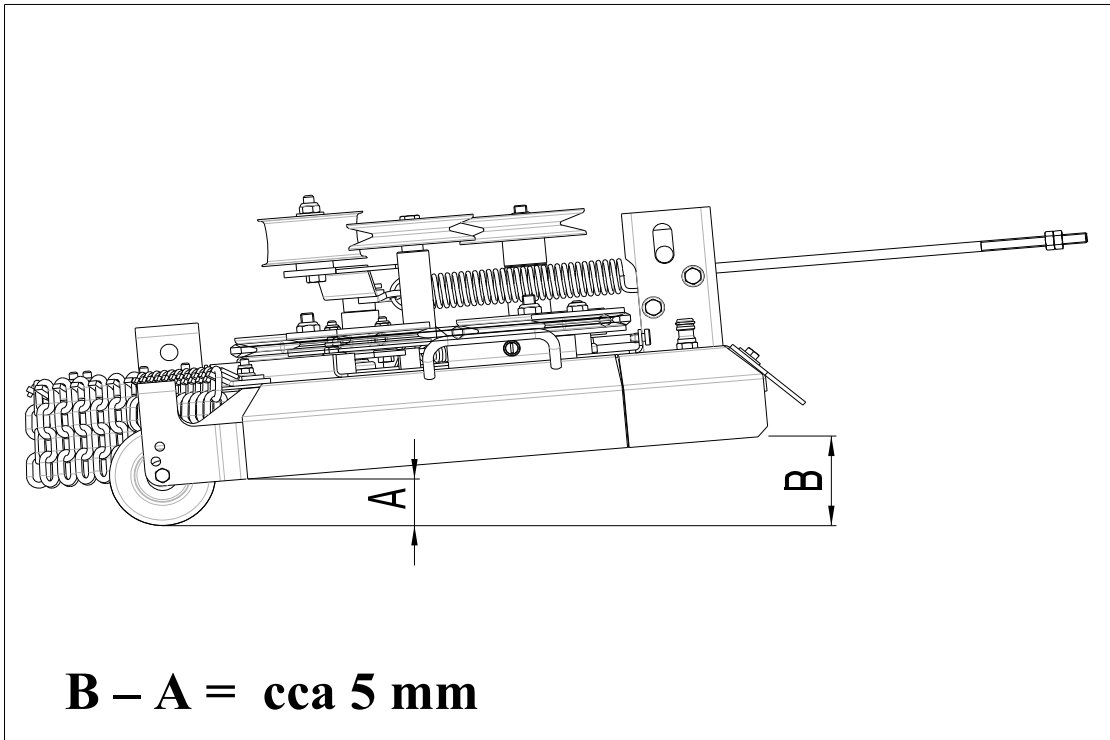

KO 28.2.2011